

ALTAIR

FASHION BATHROOM LIFE

M0136 Assembly instructions

1. Please read the instruction manual before installing and using the furniture.
2. Please assemble in strict accordance with the assembly instructions.
3. Please check carefully to ensure that all parts in the box are intact.
4. Please install it on the packing box to avoid damage to the product
5. Only use a rag or slightly damp cloth to clean the surface of the furniture, do not use strong scrubbing agents.
6. The use of unmatched hardware may cause damage to the product. Please confirm the specifications of various hardware accessories before installation.

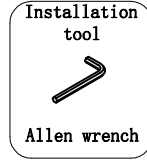
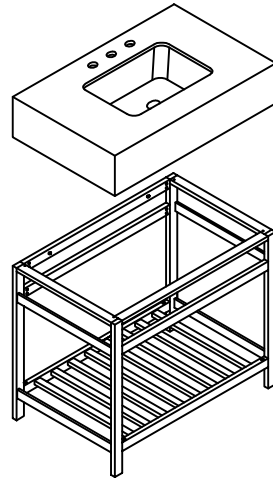

Hardware accessories list

<p>A</p>  <p>Fixing ScrewX4</p>	<p>B</p>  <p>Hexagon Socket ScrewsX26</p>	<p>C</p>  <p>Allen WrenchX2</p>
--	--	--

Components

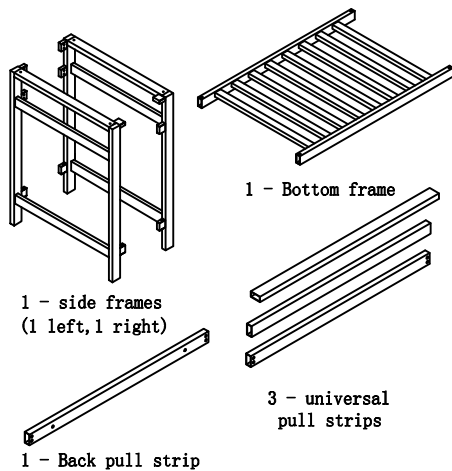

Exploded general drawing

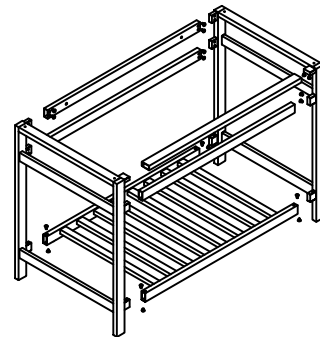

Installation steps

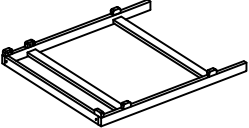
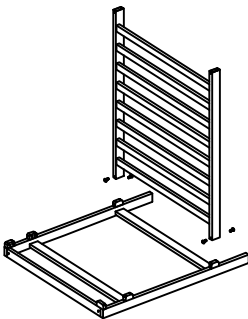
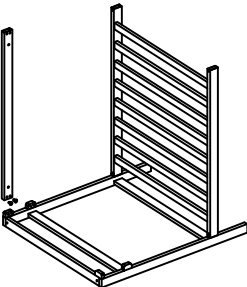
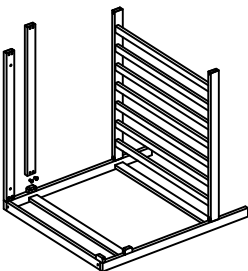
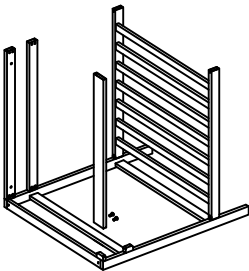
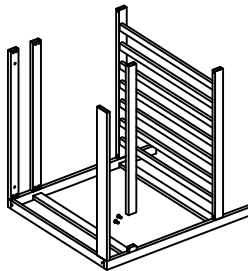
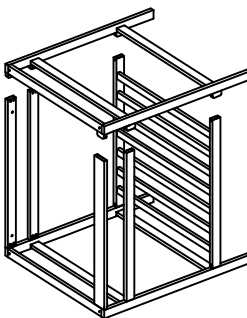
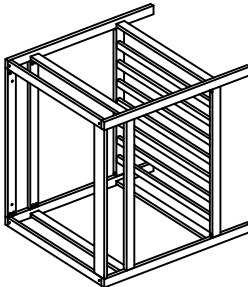
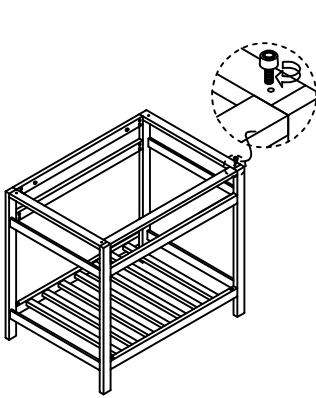
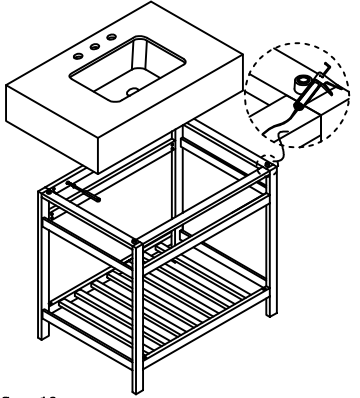
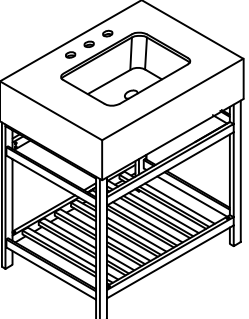
- 
- Step1:
First, lay the left border flat on the ground, paying attention to the paper skin on the pad
- 
- Step2:
The bottom shelf is then inserted into the frame and secured with hex screws
- 
- Step3:
Then slip in the rear pull-out bar
- 
- Step4:
Add universal pull strip1
- 
- Step5:
Add universal pull strip2
- 
- Step6:
Add universal pull strip3
- 
- Step7:
Then put the right border in
- 
- Step8:
Assembly complete
- 
- Step9:
Then arrange the cabinet and lock the positioning pieces
- 
- Step10:
The rear horizontal frame locks the wall, then add silicone to attach frame
- 
- Step11:
Place the countertop on the frame and the installation is complete